

UNITED STATES DISTRICT COURT
EASTERN DISTRICT OF MICHIGAN
SOUTHERN DIVISION

F&M FABRICATION CO., a Michigan corporation,
d/b/a CLASSIC 2 CURRENT FABRICATION,

Plaintiff,

vs.

Case No.

Hon.

SMOOTHIE FABRICATION, LLC,
a North Carolina limited liability company,

Defendant.

MADDIN, HAUSER, ROTH & HELLER, P.C.

By: Jonathan B. Frank (P42656)

Of Counsel

Attorney for Plaintiff

28400 Northwestern Hwy, Suite 200

Southfield, Michigan 48034

(248) 354-4030

COMPLAINT FOR DECLARATORY RELIEF

This is a case for a declaration that Defendant's copyright(s) is/are invalid and that, in any event, Plaintiff is not infringing.

1. Plaintiff F&M Fabrication Co., d/b/a Classic 2 Current Fabrication, is a Michigan corporation with its principal place of business in Redford, Michigan.
2. Plaintiff's website is www.c2cfabrication.com.
3. Defendant Smoothie Fabrication, LLC is a North Carolina limited liability company with its principal place of business in Indian Trail, North Carolina.
4. Defendant's website is www.smoothiefab.com.
5. To the best of Plaintiff's information and belief, the members of Defendant LLC are North Carolina residents.

6. Both parties are in the business of manufacturing and selling aftermarket vehicle parts.

7. Defendant has asserted that Plaintiff is infringing on its copyright(s) related to the design of certain running boards.

8. Defendant sent a cease and desist letter threatening an action for copyright infringement. Exhibit A.

9. Defendant claims to have registered its copyright(s) with the United States Copyright Office.

10. In fact, Defendant is not entitled to any copyright protection for the random markings on its products that are generated by the machining process, nor for designs intended to achieve certain strength.

11. Plaintiff is not infringing on any valid copyright.

Jurisdiction and Venue

12. This Court has subject matter jurisdiction of the claims in this action pursuant to 28 U.S.C. §§ 1332 (diversity) and 1331 (federal question), the Copyright Act at 17 U.S.C. § 501, and the Declaratory Judgment Act, 28 U.S.C. §§ 2201 and 2002.

13. Venue is proper in the judicial district pursuant to 28 U.S.C. § 1391(b)(2).

COUNT I – DECLARATORY JUDGMENT OF INVALIDITY AND NON-INFRINGEMENT OF COPYRIGHT

14. Plaintiff hereby references and incorporates the above paragraphs into this Count I as if fully set forth herein.

15. There is a substantial and continuing controversy between Plaintiff and Defendant, and a declaration of rights is both necessary and appropriate to establish that Defendant's copyright is invalid and that Plaintiff does not infringe any protectable work of Defendant.

16. Defendant's copyright is invalid because the running boards are "useful articles." Any design elements are purely functional and accomplish no aesthetic purpose.

17. In fact, the purported design elements are merely the product of a machining process and/or to accomplish a functional purpose, specifically strength.

18. A viewer cannot identify pictorial, graphic, or sculptural features within the design of the useful article.

19. The pictorial, graphic, or sculptural features of the design of the useful article do not exist independently of the utilitarian aspects of the useful article.

20. The copyright is therefore invalid under the doctrine of conceptual separability.

21. Plaintiff's running boards are likewise manufactured through a machining process that leaves marks on the final product.

22. Plaintiff's running boards are likewise designed to accomplish a functional purpose, specifically strength.

23. Plaintiff's running boards do not infringe on any valid copyright belonging to Defendant because they do not copy any protectable element of the works.

24. Defendant's cease and desist letter was sent in bad faith and in an effort to harass Plaintiff.

WHEREFORE, Plaintiff respectfully requests that this Court enter judgment as follows:

A. Declaring that Defendant's copyright(s) is/are invalid;

B. Declaring that the continued manufacture, sales, and distribution of Plaintiff's running boards will not infringe any right of Defendant; and

C. Awarding Plaintiff its costs, expenses, and reasonable attorneys' fees pursuant to 17 U.S.C. § 505.

Respectfully submitted,

MADDIN, HAUSER, ROTH & HELLER, P.C.

By: /s/ Jonathan B. Frank
Jonathan B. Frank (P42656)
Attorney for Plaintiff

Dated: January 16, 2017

UNITED STATES DISTRICT COURT
EASTERN DISTRICT OF MICHIGAN
SOUTHERN DIVISION

F&M FABRICATION CO., a Michigan corporation,
d/b/a CLASSIC 2 CURRENT FABRICATION,

Plaintiff,

vs. .

Case No.

Hon.

SMOOTHIE FABRICATION, LLC,
a North Carolina limited liability company,

Defendant.

MADDIN, HAUSER, ROTH & HELLER, P.C.

By: Jonathan B. Frank (P42656)

Of Counsel

Attorney for Plaintiff

28400 Northwestern Hwy, Suite 200

Southfield, Michigan 48034

(248) 354-4030

**EXHIBIT LIST TO
COMPLAINT FOR DECLARATORY RELIEF**

Exhibit A: Cease and desist letter

Exhibit A



Parsons Summa

A Partnership of P.L.L.C.s

November 16, 2016

VIA EMAIL & FEDEX

To:

Nick Karres
29120 Badelt St
Westland, MI 48185

Frank Laiacono
Classic Parts 4u
24536 Capitol Street
Redford, MI 48239

Michael Laiacono
Classic 2 Current
Fabrication
24536 Capitol Street
Redford, MI 48239

Dave Karres
8757 Fremont St
Westland, MI 48185

Frank Laiacono
24540 Capitol Street
Redford, MI 48239

Re: *Infringement of Smoothie Fabrication, LLC's Copyrights; Our file 1605-2016003*

Dear Messrs. Nick and Dave Karres and Frank and Michael Laiacono :

This law firm represents Smoothie Fabrication, LLC in connection with certain of its intellectual property rights.

It has come to my attention that you have made unauthorized use of my client's copyrighted running board designs titled Running Board (the "Works") identified in Appendix A attached herein in the preparation of works derived therefrom. Smoothie Fabrication, LLC reserves all rights in the Works, which were first published between 1990-2000 (See Appendix A for creation dates for each allegedly infringed item) and sold by Smoothie Fabrication, LLC since their creation. See Appendix A for dates upon which the infringing parties purchased the Works from Smoothie Fabrication, LLC, including corresponding order numbers. Copyrights have been filed with the Library of Congress (Case number 1-4028246661).

Your products itemized in Appendix B, which appear on the Classic Parts 4U and Classic 2 Current Fabrication eBay, Amazon, and Alibaba seller accounts are essentially identical to the Works and clearly used the Works as their basis. You neither asked for nor received permission to use the Works as the basis for the infringing items identified in Appendix B nor to make or distribute copies of them. Appendix B comprises a representative list of infringing items, and analogous relistings will constitute additional incidents of infringement.

Therefore, it appears that you have willfully infringed my client's rights under 17 U.S.C. Section 101 et seq. and could be liable for statutory damages as high as \$150,000 per incident of infringement as set forth in Section 504(c)(2) therein. Copyright law provides

Smoothie Fabrication
November 16, 2016
Page 2

numerous remedies for copyright infringement, including, but not limited to, preliminary and permanent injunctive relief, money damages, provisions for the destruction or confiscation of infringing products and promotional materials—and where intentional infringement is shown, attorney's fees and treble money damages.

This letter constitutes Smoothie Fabrication, LLC's demand that you cease and desist any and all use of the Smoothie Fabrication, LLC's copyrighted materials attached herein. This letter is sent without prejudice to Smoothie Fabrication, LLC's rights and claims, all of which are expressly reserved. You should immediately forward this letter to your attorney.

Please immediately cease and desist from any and all infringing activity, including use of the Smoothie Fabrication, LLC's photographs and designs in conjunction with the sale, promotion, or marketing of your goods. Please indicate your understanding of this demand within ten (10) business days of receipt of this letter.

Very truly yours,

A handwritten signature in black ink, appearing to read 'REA', with a large, sweeping flourish underneath.

Rebeca E. Harasimowicz
Attorney at law

APPENDIX A

The Works being infringed

Creation				
Date	Order Date	Job #	Description	Ship Date
6/20/1991	1/11/16	16008	1941-46 CHEVY TRUCK	1/26/16
11/4/1998		16008-1	1947-54 CHEVY TRUCK	2/1/16
1/29/1996	2/1/16	16015	1953-56 FORD F100	2/11/16
9/18/2013		16015-1	1931-32 CHEVY CAR	2/18/16
6/25/1992	2/14/16	16026	1935-36 CHEVY MASTER	2/16/16
2/21/2006		16026-1	1948-52 FORD F1	2/16/16
8/17/2000		16026-2	1933-35-CHEVY STANDARD	2/17/16
7/19/1996		16026-5	1953-56 FORD F100 PANEL	3/9/16
7/17/1997	3/9/16	16050-1	1937-38 PONTIAC	3/11/16
12/22/2000		16050-2	1934 CHEVY MASTER	3/11/16
2/19/1991		16050-3	1937-39 FORD CAR	3/29/16
10/1/99		16050-5	1937-39 DODGE CAR	4/1/16
3/15/2002		16050-6	1942-47 FORD TRUCK	5/7/16
5/5/1990		16065-3	1934-36 CHEVY TRUCK	5/19/16
4/12/1990		16065-5	1936-38 DODGE TRUCK	5/19/16
11/15/1999		16084-3	1942-47 DODGE TRUCK	6/27/16
8/9/1993		16084-6	1940-41 PLYMOUTH	7/6/16
10/1/1998		16084-7	1938-39 FORD TRUCK	7/6/16
1/19/1993		16103-5	1940-41 FORD TRUCK	8/2/16

APPENDIX B

Hi Michael! Daily Deals Gift Cards Sell Help & Contact

Prep Your Home for Joy

My eBay



Shop by category

Search...

All Categories



Search

Advanced

Back to search results | Listed in category: eBay Motors > Parts & Accessories > Car & Truck Parts > Exterior > Other

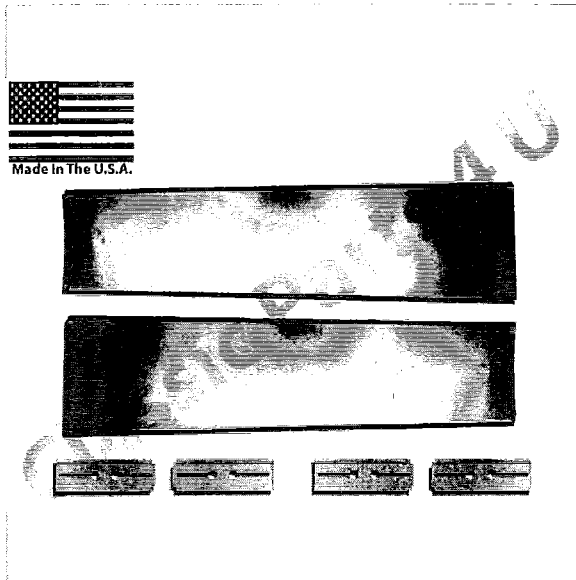

1931 1932 Chevy Chevrolet Car Steel Running Board Set NEW PAIR

Item condition: **New** | [Add to watch list](#)
 Sale ends in: **05h 55m 09s**
 Quantity: Last one / 1 sold

Seller information
classicparts4u (36541)
 99.7% Positive feedback

Was: **US \$324.99**
 You save: **\$45.08 (14% off)**
 Price: **US \$276.91** Buy It Now

Follow this seller
 Visit store: classicparts4u
 See other items

[Add to cart](#)
 1 watching [Add to watch list](#)
[Add to collection](#)

More than 49% sold Last item available Experienced seller

Shipping: **FREE Standard Shipping** | [See details](#)
 Item location: Westland, Michigan, United States
 Ships to: United States [See restrictions](#)

Delivery: Estimated on or before **Fri, Nov. 18** to 64109

Payments: **PayPal** VISA
 Credit Cards processed by PayPal

PayPal CREDIT
 6 months to pay on \$99+. [Apply Now](#) | [See Terms](#)
[See details](#)

Returns: **30 days money back, buyer pays return shipping** | [See details](#)

Guarantee: [See details](#) | [See](#)
 Get the item you ordered or get your money back.
 Covers your purchase price and original shipping.

Have one to sell? [Sell now](#)

People who viewed this item also viewed

[Feedback on our suggestions](#)



1966 67 68 69 70 71 72 73
 74 75 76 77 BRONCO
\$79.11
 Free shipping

Description Shipping and payments Report item

Seller assumes all responsibility for this listing.

eBay item number: 201710428594

Item specifics

Condition:	New	Brand:	ClassicParts4u
Placement on Vehicle:	Left & Right	Primary Color:	Unfinished
Country of Manufacture:	United States	Manufacturer Part Number:	C-3132RB
Part Brand:	ClassicParts4U	Surface Finish:	Non Coated Steel
Interchange Part Number:	1931 1932	Country/Region of Manufacture:	United States



Shop by category

Search...

All Categories



Search

Advanced

Back to search results | Listed in category: eBay Motors > Parts & Accessories > Car & Truck Parts > Exterior > Other

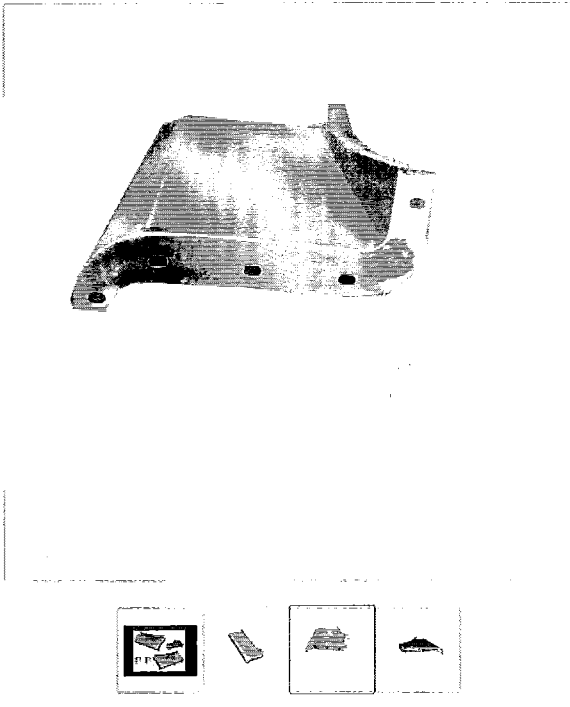

Have one to sell? Sell now

1933,1934,1935 Chevrolet Chevy Standard Steel Running Board Set 33,34,35 NEW!!

1 sold in last 24 hours

Item condition: **New**

[Add to watch list](#)

Compatibility: See compatible vehicles

Sale ends in: **05h 28m 07s**

Quantity: Last one / 1 sold

Was: ~~US \$459.99~~

You save: \$64.40 (14% off)

Price: **US \$395.59** Buy It Now
From \$36 for 12 months*

[Add to cart](#)

3 watching

[Add to watch list](#)

[Add to collection](#)

More than 49% sold | Last item available | Experienced seller

Shipping: **FREE** Standard Shipping | [See details](#)

Item location: Westland, Michigan, United States
Ships to: United States | [See exclusions](#)

Delivery: Estimated on or before **Fri, Nov. 18** to 64109

Payments: **PayPal** | **VISA** | |

Credit Cards processed by PayPal

PayPal CREDIT

* From \$36 for 12 months. Minimum purchase required.
[Apply Now](#) | [See Terms](#)
[See details](#)

Returns: **30 days money back, buyer pays return shipping** | [See details](#)

Guarantee: [details](#) | [See](#)

Get the item you ordered or get your money back.
Covers your purchase price and original shipping.

Seller information

classicparts4u (36541) [\(\)](#)
99.7% Positive feedback

[Follow this seller](#)

Visit store: [classicparts4u](#)
[See other items](#)



People who viewed this item also viewed

[Feedback on our suggestions](#)

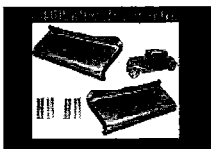

Chevrolet Chevy Standard Steel Running Board Set
\$395.59
Free shipping

Description

Shipping and payments

Report item

Seller assumes all responsibility for this listing.

eBay item number: 401220715636

Compatibility



Shop by category

Search...

All Categories



Search

Advanced

Back to search results | Listed in category: eBay Motors > Parts & Accessories > Car & Truck Parts > Exterior > Other



1934 1935 1936 Chevy Pickup Truck 1/2 Ton and Panel Delivery Running Boards

Item condition: **New** | [Add to watch list](#)

Compatibility: See compatible vehicles

Sale ends in: 06h 03m 34s

Quantity: 2 available

Was: ~~US \$429.99~~

You save: \$60.20 (14% off)

Price: **US \$369.79** Buy It Now
From \$34 for 12 months*

3 watching | [Add to watch list](#)
[Add to collection](#)

Experienced seller | Free shipping | 30-day returns

Seller information
classicparts4u (36541)
 99.7% Positive feedback

[Follow this seller](#)

Visit store: [classicparts4u](#)
[See other items](#)



Have one to sell? [Sell now](#)

Shipping: **FREE** Standard Shipping | [See details](#)
 Item location: Westland, Michigan, United States
 Ships to: United States | [See exclusions](#)

Delivery: Estimated on or before **Fri. Nov. 18** to 64109

Payments: **PayPal**

Credit Cards processed by PayPal

PayPal CREDIT
 * From \$34 for 12 months. Minimum purchase required.
[Apply Now](#) | [See Terms](#)
[See details](#)

Returns: **30 days money back**, buyer pays return shipping | [See details](#)

Guarantee: [See details](#)
 Get the item you ordered or get your money back.
 Covers your purchase price and original shipping.

People who viewed this item also viewed

[Feedback on our suggestions](#)

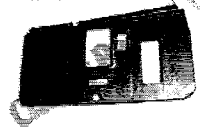

1936 1937 1938 CHEVY PICKUP TRUCK GMC
 \$93.95
 Free shipping



ROCKER PANELS AND CAB CORNERS 99-06
 \$99.00
 + \$25.00



1937 1938 1939 Chevy Gmc Stepside Truck Rear Roll
 \$167.69
 Free shipping



1958 - 1969 Toyota Land Cruiser FJ40 rear quarter
 \$189.19
 Free shipping

Description

Shipping and payments

[Report item](#)

Seller assumes all responsibility for this listing.

Last updated on Nov 07, 2016 22:51:19 PST [View all revisions](#)

eBay item number: 201705456563

Compatibility

To confirm that this part fits your vehicle, please choose a vehicle from your My Vehicles list OR enter your vehicle's Year, Make and Model.



Shop by category

Search...

All Categories



Search

Advanced

Back to search results | Listed in category: eBay Motors > Parts & Accessories > Car & Truck Parts > Exterior > Other

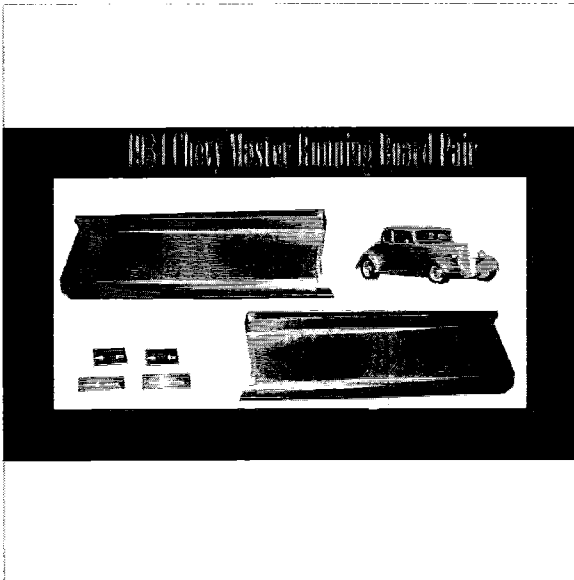

1934 Chevrolet Chevy Master Steel Running Board Set - Made in USA 16 Gauge

Item condition: **New** | [Add to watch list](#)
 Compatibility: See compatible vehicles
 Sale ends in: 05h 58m 02s

Quantity: 2 available

Was: ~~US \$429.99~~

You save: \$60.20 (14% off)

Price: **US \$369.79** Buy It Now
 From \$34 for 12 months*

[Add to cart](#)

5 watching | [Add to watch list](#)
[Add to collection](#)

Experienced seller | Free shipping | 30-day returns

Seller information
classicparts4u (36541)
 99.7% Positive feedback

[Follow this seller](#)

Visit store: classicparts4u
[See other items](#)



Have one to sell? [Sell now](#)

Shipping: **FREE** Standard Shipping | [See details](#)

Item location: Westland, Michigan, United States

Ships to: United States | [See exclusions](#)

Delivery: Estimated on or before **Fri. Nov. 18** to 64109

Payments: **PayPal**

Credit Cards processed by PayPal

PayPal CREDIT

* From \$34 for 12 months. Minimum purchase required.

[Apply Now](#) | [See Terms](#)

[See details](#)

Returns: 30 days money back, buyer pays return shipping |

[See details](#)

Guarantee: [See details](#) | [See](#)

Get the item you ordered or get your money back.
 Covers your purchase price and original shipping.

Description

Shipping and payments

Report item

eBay item number: 142154995885

Seller assumes all responsibility for this listing.

Compatibility

To confirm that this part fits your vehicle, please choose a vehicle from your My Vehicles list OR enter your vehicle's Year, Make and Model.

My Vehicles

Select a vehicle



Year: | Make: | Model: | Trim: | Engine: |

Manage vehicles

Save to My Vehicles to finds parts faster

[\(show all compatible vehicles\)](#)

This part is compatible with 1 vehicle(s).

Notes	Year	Make	Model	Trim	Engine
	1934	Chevrolet	Master	Base	3.4L 3389CC 207Cu. In. I6 GAS OHV Naturally Aspirated

Portions of the information contained in this table have been provided by classicparts4u

Item specifics

Condition:	New	Brand:	ClassicParts4u
Country/Region of Manufacture:	United States	Primary Color:	Unfinished
Country of Manufacture:	United States	Manufacturer Part Number:	C-34RB
Part Brand:	ClassicParts4U	Placement on Vehicle:	Left, Right
Interchange Part Number:	1934	Surface Finish:	Non Coated Steel



Shop by category

Search...

All Categories



Search

Advanced

Back to search results | Listed in category: eBay Motors > Parts & Accessories > Car & Truck Parts > Exterior > Other

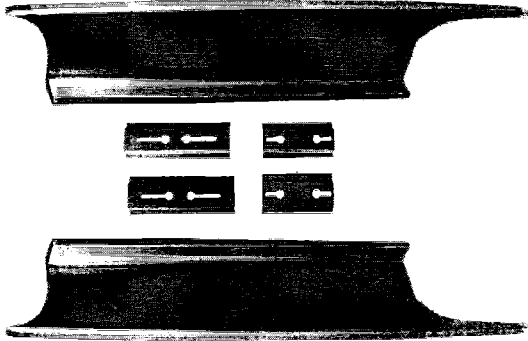

Have one to sell? Sell now

1935 1936 Chevrolet Chevy Master Car Steel Running Board Set - Made in USA

1 sold in last 24 hours

Item condition: **New**

[Add to watch list](#)

Sale ends in: **05h 25m 10s**

Quantity: Last one / 1 sold

Was: ~~US \$489.99~~

You save: \$68.60 (14% off)

Price: **US \$421.39**

From \$39 for 12 months

[Buy It Now](#)

[Add to cart](#)

4 watching

[Add to watch list](#)

[Add to collection](#)

More than 49% sold

Last item available Experienced seller

Seller information

classicparts4u (36541)

99.7% Positive feedback

[Follow this seller](#)

Visit store: classicparts4u
See other items

READY TO SELL? JUST DROP IT OFF!

Find eBay Valet at 1,600+ FedEx Office locations

[Get started](#)

Shipping: **FREE** Standard Shipping | [See details](#)

Item location: Westland, Michigan, United States

Ships to: United States | [See exclusions](#)

Delivery: Estimated on or before **Fri, Nov. 18** to 64109

Payments: **PayPal** VISA

Credit Cards processed by PayPal

PayPal CREDIT

* From \$39 for 12 months. Minimum purchase required.

[Apply Now](#) | [See Terms](#)

[See details](#)

Returns: **30 days money back, buyer pays return shipping** |

[See details](#)

Guarantee: [See details](#)

Get the item you ordered or get your money back.
Covers your purchase price and original shipping.

People who viewed this item also viewed

[Feedback on our suggestions](#)

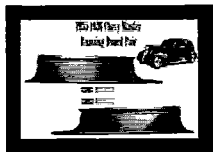

Chevrolet Chevy Master Car Steel Running Board Set

\$429.99
Free shipping



1937 1938 Chevy Chevrolet Car Steel Running Board Set

\$318.19
Free shipping



Chevrolet Chevy Car Firewall Small Block 2" Setback

\$299.27
Free shipping



1936 Chevrolet Standard 2 Door Sedan Auto Glass Kit

\$390.00



REBUILT CHEVY 4L60E transmission w/ receipt

\$1,000.00
+ \$0.00

Description Shipping and payments

[Report item](#)

Seller assumes all responsibility for this listing.

eBay Item number: 142165793013

Item specifics

Condition: New
Surface Finish: Non Coated Steel
Country/Region of Manufacture: United States

Brand: ClassicParts4u
Primary Color: Unfinished
Manufacturer Part Number:



Shop by category

Search...

All Categories



Search

Advanced

Back to search results | Listed in category: eBay Motors > Parts & Accessories > Car & Truck Parts > Exterior > Other

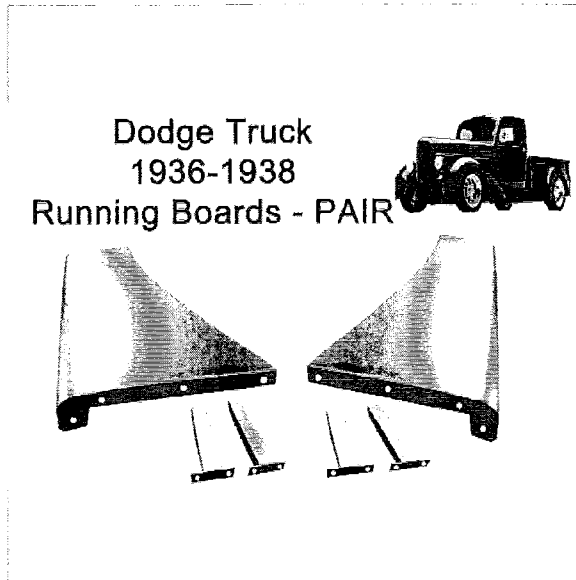

1936,1937,1938 Dodge Pickup Truck Steel Running Board Set 36,37,38 - Made in USA

Item condition: **New**
 Sale ends in: 05h 41m 38s
 Quantity: 2 available

[Add to watch list](#)

Was: ~~US \$499.99~~

You save: \$70.00 (14% off)

Price: **US \$429.99**

From \$39 for 12 months*

[Buy It Now](#)

[Add to cart](#)

8 watching

[Add to watch list](#)

[Add to collection](#)

Experienced seller

Free shipping

30-day returns

Seller information

classicparts4u (36541)
 99.7% Positive feedback

[Follow this seller](#)

Visit store: classicparts4u

[See other items](#)

Have one to sell? [Sell now](#)

Shipping: **FAST 'N FREE**

On or before **Thu, Nov. 17** to 64109

Item location: Wheeland, Michigan, United States

Ships to: United States [See exceptions](#)

Payments: **PayPal** **VISA**

Credit Cards processed by PayPal

PayPal CREDIT

* From \$39 for 12 months. Minimum purchase required.

[Apply Now](#) | [See Terms](#)

[See details](#)

Returns: 30 days money back, buyer pays return shipping |

[See details](#)

Guarantee: [See details](#)

Get the item you ordered or get your money back.
 Covers your purchase price and original shipping.

People who viewed this item also viewed

[Feedback on our suggestions](#)

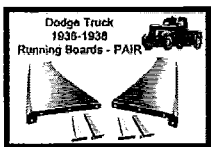

Dodge Pickup Truck Steel Running Board Set 36,37,38
 \$429.99
 Free shipping



Dodge Pickup Truck Steel Running Board Set 36,37,38
 \$535.00



1936-38 DODGE TRUCK 1937-38 PLYMOUTH
 \$139.99
 Free shipping

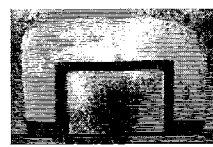

*Dodge Passenger Car Firewall - 3" Set-Back /
 \$380.00



Dodge Steel Running Board Set 35,36 1935-1936 - Made
 \$535.00



1935 - 1936 Dodge & Plymouth Car Poly Gas Tank
 \$269.99
 Free shipping

Description Shipping and payments

[Report item](#)

Seller assumes all responsibility for this listing.

eBay Item number: 201602965218

Item specifics

Condition:	New	Brand:	ClassicParts4u
Placement on Vehicle:	Left, Right	Primary Color:	Unfinished
Surface Finish:	Non Coated Steel	Manufacturer Part Number:	DO-3638RB
Country/Region of Manufacture:	United States	Interchange Part Number:	1936, 1937, 1938

Hi Michael! Daily Deals Gift Cards Sell Help & Contact

Prep Your Home for Joy

My eBay



Shop by category

Search...

All Categories



Search

Advanced

Back to search results | Listed in category: eBay Motors > Parts & Accessories > Car & Truck Parts > Exterior > Other

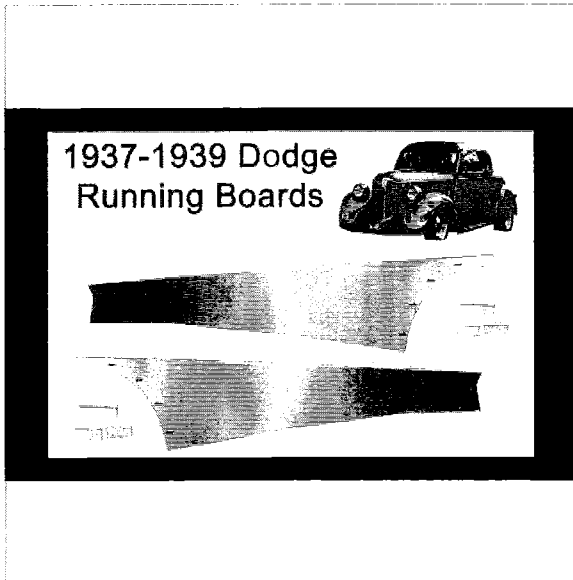

1937,1938,1939 Dodge Passenger Steel Running Board Set - Made in USA 16 Gauge

Item condition: **New** | Add to watch list
 Compatibility: See compatible vehicles
 Sale ends in: **05h 35m 15s**
 Quantity: Last one / 1 sold
 Was: ~~US \$449.99~~

Seller information
classicparts4u (36541)
 99.7% Positive feedback

Follow this seller

Visit store: classicparts4u
 See other items

You save: \$63.00 (14% off)
 Price: **US \$386.99** Buy It Now
From \$35 for 12 months*
 Add to cart
 Add to watch list
 Add to collection

More than 49% sold Last item available Experienced seller

Shipping: **FREE** Standard Shipping | [See details](#)
Item location: Westland, Michigan, United States
 Ships to: United States [See exceptions](#)

Delivery: Estimated on or before **Fri, Nov. 18** to 64109

Payments: **PayPal**
Credit Cards processed by PayPal

PayPal CREDIT
* From \$35 for 12 months. Minimum purchase required.
[Apply Now](#) | [See Terms](#)
[See details](#)

Returns: **30 days money back**, buyer pays return shipping | [See details](#)

Guarantee: [details](#) | [See](#)
Get the item you ordered or get your money back.
 Covers your purchase price and original shipping.



Have one to sell? Sell now

Description

Shipping and payments

Report item

eBay item number: 401211904040

Seller assumes all responsibility for this listing.

Compatibility

To confirm that this part fits your vehicle, please choose a vehicle from your My Vehicles list OR enter your vehicle's Year, Make and Model.

My Vehicles

Select a vehicle

or

Year: [-Select-] Make: [-Select-] Model: [-Select-] Trim: [All Trims] Engine: [All Engines] Go

Manage vehicles

Save to My Vehicles to finds parts faster

[show all compatible vehicles]

This part is compatible with 3 vehicle(s).

Notes	Year	Make	Model	Trim	Engine
	1939	Dodge	Deluxe	Base	--
	1938	Dodge	Deluxe	Base	--
	1937	Dodge	Deluxe	Base	--

Portions of the information contained in this table have been provided by classicparts4u

Item specifics

Condition: New Brand: ClassicParts4u
 Country/Region of Manufacture: United States Primary Color: Unfinished



Shop by category

Search...

All Categories



Search

Advanced

Back to search results | Listed in category: eBay Motors > Parts & Accessories > Car & Truck Parts > Exterior > Other



1937 1938 1939 Ford Car Steel Running Board Set NEW PAIR!! Made in USA

Item condition: New
Compatibility: See compatible vehicles
Sale ends in: 05h 45m 18s
Quantity: 1 Last one / 1 sold
Was: US \$445.99

You save: \$62.44 (14% off)
Price: US \$383.55 Buy It Now
From \$35 for 12 months*
Add to cart
Add to watch list
Add to collection

More than 49% sold Last item available Experienced seller

Seller information classicparts4u (36541) 99.7% Positive feedback

Follow this seller Visit store: classicparts4u See other items



Have one to sell? Sell now

Shipping: FREE Standard Shipping | See details
Item location: Westland, Michigan, United States
Ships to: United States | See exclusions

Delivery: Estimated on or before Fri. Nov. 18 to 64109

Payments: PayPal VISA MasterCard American Express
Credit Cards processed by PayPal

PayPal CREDIT
* From \$35 for 12 months. Minimum purchase required.
Apply Now | See Terms
See details

Returns: 30 days money back, buyer pays return shipping | See details

Guarantee: Get the item you ordered or get your money back. Covers your purchase price and original shipping.

People who viewed this item also viewed

Feedback on our suggestions

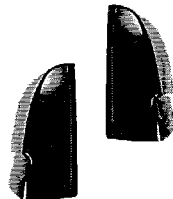

Ford Car Steel Running Board Set 1937,1938,1939 \$383.55 Free shipping

1988-1998 CHEVROLET C/K 1500 CAB CORNERS \$33.72 Free shipping

Description Shipping and payments

Report item

eBay item number: 201704121947

Seller assumes all responsibility for this listing.

Compatibility

To confirm that this part fits your vehicle, please choose a vehicle from your My Vehicles list OR enter your vehicle's Year, Make and Model.

My Vehicles | Year Make Model Trim Engine



Shop by category

Search...

All Categories



Search

Advanced

Back to search results | Listed in category: eBay Motors > Parts & Accessories > Car & Truck Parts > Exterior > Other

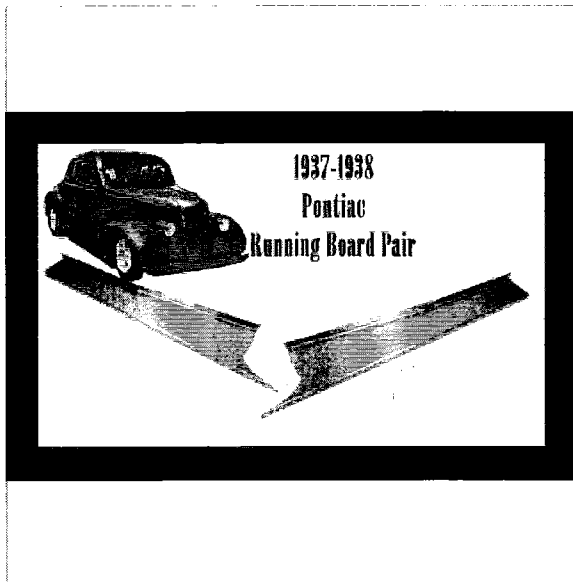

1937 1938 Pontiac Steel Running Board Set 37,38 - Made in USA 16 Gauge

1 watched in last 24 hours

Item **New**
condition:

| Add to watch list

Compatibility: See compatible vehicles

Sale ends **06h 18m 13s**
in:

Quantity: Last one / 1 sold

Was: ~~US \$461.49~~

You save: \$64.61 (14% off)

Price: **US \$396.88** Buy It Now
From \$36 for 12 months

Add to cart

4 watching

Add to watch list

Add to collection

More than 49% sold | Last item available | Experienced seller

Seller information

classicparts4u (36540)
99.7% Positive feedback

Follow this seller

Visit store: classicparts4u
See other items

Have one to sell? Sell now

Shipping: **FAST 'N' FREE**
On or before **Thu. Nov. 17** to 64109
Item location: Westland, Michigan, United States
Ships to: United States [See exclusions](#)

Payments: **PayPal** **VISA**
Credit Cards processed by PayPal

PayPal CREDIT
* From \$36 for 12 months. Minimum purchase required.
[Apply Now](#) | [See Terms](#)
[See details](#)

Returns: **30 days money back, buyer pays return shipping** |
[See details](#)

Guarantee: | [See details](#)
Get the item you ordered or get your money back.
Covers your purchase price and original shipping.

People who viewed this item also viewed

[Feedback on our suggestions](#)



1937 1938 Chevy Chevrolet
Car Steel Running Board Set
\$318.19
Free shipping

Description Shipping and payments

[Report item](#)

Seller assumes all responsibility for this listing.

eBay item number 142165609986

Compatibility

To confirm that this part fits your vehicle, please choose a vehicle from your My Vehicles list OR enter your vehicle's Year, Make and Model

My Vehicles | Year | Make | Model | Trim | Engine

Hi Michael! Daily Deals Gift Cards Sell Help & Contact

Prep Your Home for Joy

My eBay



Shop by category

Search...

All Categories



Search

Advanced

Back to search results | Listed in category: eBay Motors > Parts & Accessories > Car & Truck Parts > Exterior > Other

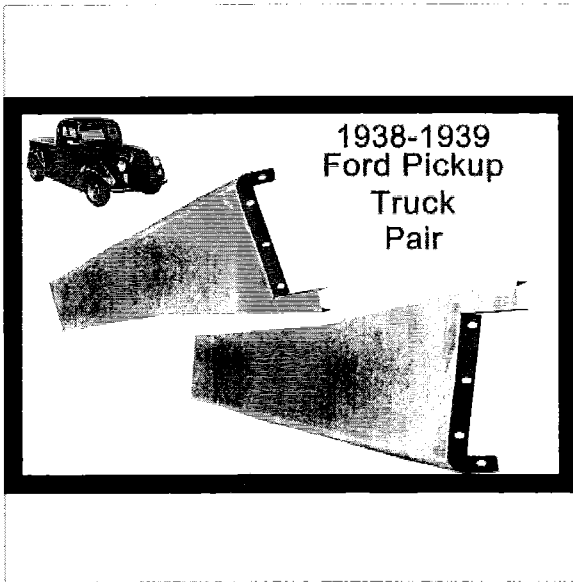

1938 1939 Ford Pickup Truck 1/2 Ton Steel Running Board Set NEW PAIR!

Item condition: **New** | Add to watch list
Compatibility: See compatible vehicles
Sale ends in: 05h 37m 37s
Quantity: 2 available

Was: ~~US \$434.99~~
You save: \$80.90 (14% off)
Price: **US \$374.09** Buy It Now
From \$34 for 12 months*

3 watching | Add to watch list | Add to collection
Experienced seller | Free shipping | 30-day returns

Seller information
classicparts4u (36541) | 99.7% Positive feedback
Follow this seller
Visit store: classicparts4u
See other items

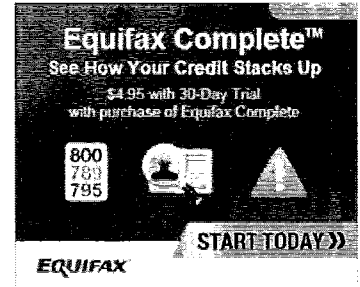

Have one to sell? Sell now

Shipping: **FAST 'N FREE**
On or before **Thu. Nov. 17** to 64109
Item location: Westland, Michigan, United States
Ships to: United States | See exclusions

Payments: **PayPal** | **VISA** | **MasterCard** | **Discover** | **AMERICAN EXPRESS**
Credit Cards processed by PayPal

PayPal CREDIT
* From \$34 for 12 months. Minimum purchase required.
[Apply Now](#) | [See Terms](#)
[See details](#)

Returns: **30 days money back, buyer pays return shipping** | [See details](#)

Guarantee: [See details](#)
Get the item you ordered or get your money back.
Covers your purchase price and original shipping.

People who viewed this item also viewed

Feedback on our suggestions

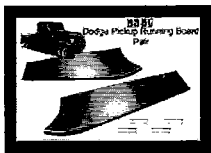

1939 1940 1941 1942 1946
1947 Dodge Pickup Truck
\$451.49
Free shipping

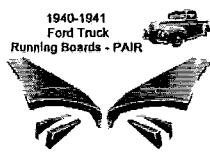

1940-1941 Ford Truck
Running Boards - PAIR
Ford Pickup Truck 1/2 TON
Steel Running Board Set
\$392.15
Free shipping

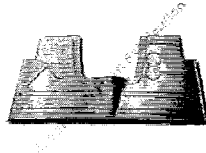

1942 1946 1947 Ford Pickup
Truck Complete Front Floor
\$85.49
Free shipping

Description Shipping and payments

Report item

eBay item number: 142162820182

Seller assumes all responsibility for this listing

Compatibility

To confirm that this part fits your vehicle, please choose a vehicle from your My Vehicles list OR enter your vehicle's Year, Make and Model.

My Vehicles

Select a vehicle



Year: [-Select-] | Make: [-Select-] | Model: [-Select-] | Trim: [All Trims] | Engine: [All Engines] | Go

Hi Michael! Daily Deals Gift Cards Sell Help & Contact

Prep Your Home for Joy

My eBay



Shop by category

Search...

All Categories



Search

Advanced

Back to search results | Listed in category: eBay Motors > Parts & Accessories > Car & Truck Parts > Exterior > Other

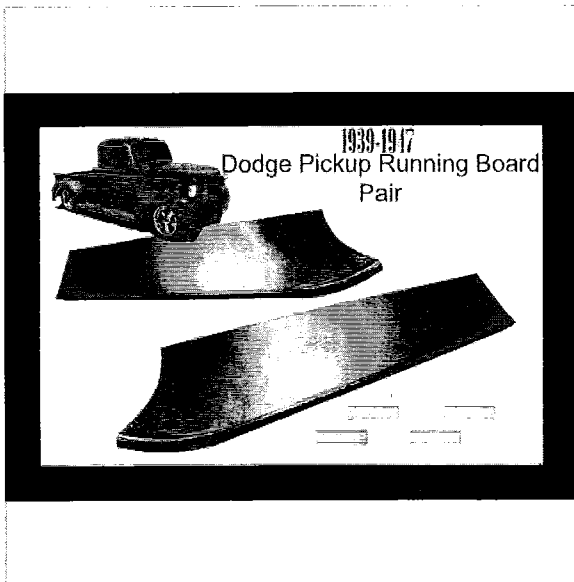

1939 1940 1941 1942 1946 1947 Dodge Pickup Truck 1/2 TON Steel Running Board Set

Item condition: **New**
 Compatibility: See compatible vehicles
 Sale ends in: 05h 04m 31s
 Quantity: 2 available

Was: US \$624.99
 You save: \$73.50 (14% off)
 Price: **US \$451.49**
 From \$41 for 12 months

4 watching

Experienced seller Free shipping 30-day returns

| Add to watch list

Seller information
 classicparts4u (36542)
 99.7% Positive feedback

Follow this seller

Visit store: classicparts4u
 See other items



LEARN HOW TO EARN \$30 BACK

as a statement credit if you are approved for a new eBay Extras MasterCard® account.

Learn More



Have one to sell? Sell now

Shipping: **FAST N FREE**
 On or before **Thu, Nov. 17** to 64109
 Item location: Westland, Michigan, United States
 Ships to: United States [See shipping](#)

Payments: **PayPal** VISA
 Credit Cards processed by PayPal

PayPal CREDIT
 * From \$41 for 12 months. Minimum purchase required
[Apply Now](#) | [See Terms](#)
[See details](#)

Returns: 30 days money back, buyer pays return shipping | [See details](#)

Guarantee: [details](#) | [See](#)
 Get the item you ordered or get your money back.
 Covers your purchase price and original shipping.

People who viewed this item also viewed

Feedback on our suggestions



1940-1941 Ford Truck Running Boards - PAIR
 Ford Pickup Truck 1/2 TON Steel Running Board Set
 \$392.15
 Free shipping

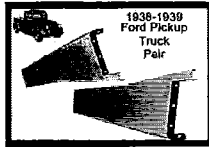

1938-1939 Ford Pickup Truck 1/2 Ton Steel Running
 \$374.09
 Free shipping

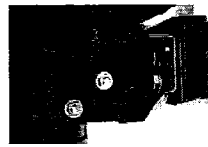

Rock Hard 4x4 Heavy Duty Rear Frame Brace Kit 76-86
 \$49.95
 + \$10.00



1942 1946 1947 Ford Pickup Truck Complete Front Floor
 \$85.49
 Free shipping



m² outfitters
 Smittybilt 2761 Security Storage Vault Textured Black
 \$369.99
 Free shipping

Description Shipping and payments

Report item

Seller assumes all responsibility for this listing

eBay item number 201696331549

Compatibility

To confirm that this part fits your vehicle, please choose a vehicle from your My Vehicles list OR enter your vehicle's Year, Make and Model.

My Vehicles Year Make Model Trim Engine



Shop by category

Search...

All Categories



Search

Advanced

Back to search results | Listed in category: eBay Motors > Parts & Accessories > Car & Truck Parts > Exterior > Other

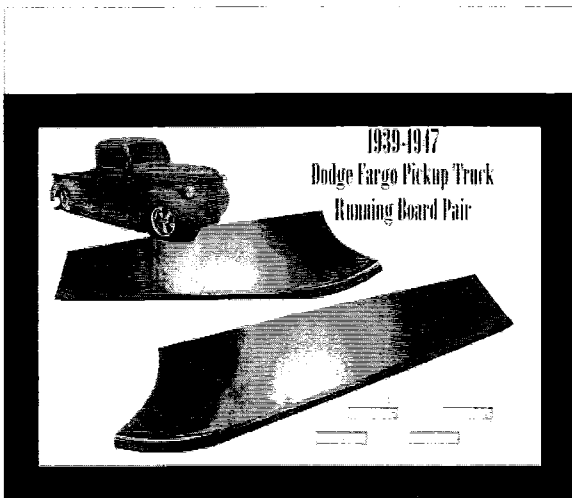

1939 1940 1941 1942 1946 1947 Fargo Pickup Truck 1/2 TON Steel Running Board SET

Item: **New**
 condition:
 Sale ends: 05h 07m 48s in:
 Quantity: 2 available

[Add to watch list](#)

Was: ~~US \$524.99~~
 You save: \$73.50 (14% off)

Price: **US \$451.49**
 From \$41 for 12 months*

[Buy It Now](#)

[Add to cart](#)

[Add to watch list](#)

[Add to collection](#)

Experienced seller | Free shipping | 30-day returns

Seller information
classicparts4u (36541)
 99.7% Positive feedback

[Follow this seller](#)

[Visit store: classicparts4u](#)
[See other items](#)



LEARN HOW TO EARN \$30 BACK

as a statement credit if you are approved for a new eBay Extras MasterCard® account.



Shipping: **FAST 'N FREE**
 On or before **Thu. Nov. 17** to 64109
 Item location: Westland, Michigan, United States
 Ships to: United States [See exclusions](#)

Payments: **PayPal** | VISA | MasterCard | Discover | American Express
 Credit Cards processed by PayPal

PayPal CREDIT
 * From \$41 for 12 months. Minimum purchase required
[Apply Now](#) | [See Terms](#)
[See details](#)

Returns: 30 days money back, buyer pays return shipping | [See details](#)

Guarantee: [See details](#)
 Get the item you ordered or get your money back.
 Covers your purchase price and original shipping.



[Have one to sell?](#) [Sell now](#)

Description | Shipping and payments | Report item

Seller assumes all responsibility for this listing.

eBay item number: 401210880852

Item specifics

Condition:	New	Brand:	ClassicParts4u
Placement on Vehicle:	Left, Right	Primary Color:	Unfinished
Surface Finish:	Non Coated Steel	Manufacturer Part Number:	F-3947RB
Country/Region of Manufacture:	United States	Interchange Part Number:	1939,1940,1941,1942,1943,1944,1945,1946,1947
Country of Manufacture:	United States	Other Part Number:	39,40,41,42,43,44,45,46,47
Part Brand:	ClassicParts4U		

Top quality running board set made in the US from 16 gauge steel. Complete set of left and right hand running boards. Non ribbed smooth boards allow you to finish as desired. Bolts up nicely to original mounting points AND FITS THE FOLLOWING 1/2 TON TRUCKS: 1939 FARGO PICKUP TRUCK , 1940 FARGO PICKUP TRUCK , 1941 FARGO PICKUP TRUCK , 1942 FARGO PICKUP TRUCK , 1943 FARGO PICKUP TRUCK , 1944 FARGO PICKUP TRUCK , 1945 FARGO PICKUP TRUCK , 1946 FARGO PICKUP TRUCK , 1947 FARGO PICKUP TRUCK , . YOU WONT FIND THEM ANY CHEAPER THEN THIS SO DONT MISS OUT.

On Feb-08-03 at 12:07:21 PST, seller added the following information:

After purchasing, pay instantly with your credit card through PayPal!



Hi Michael! Daily Deals Gift Cards Sell Help & Contact

Prep Your Home for Joy

My eBay



Shop by category Search...

All Categories



Search

Advanced

Back to search results | Listed in category: eBay Motors > Parts & Accessories > Car & Truck Parts > Exterior > Other

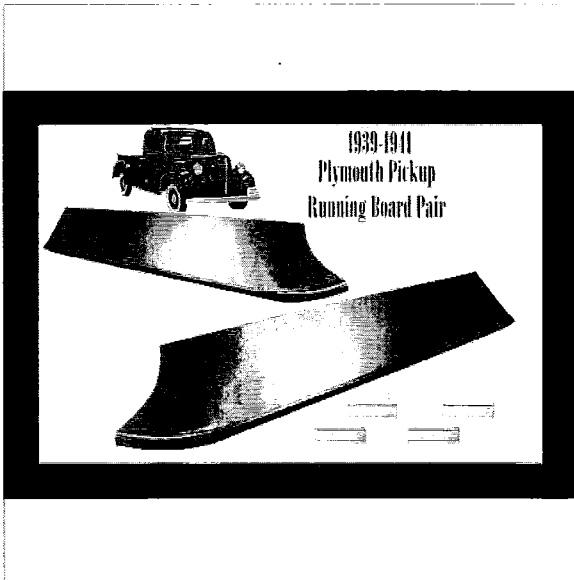

1939 1940 1941 Plymouth Pickup Truck 1/2 TON Steel Running Boards

Item condition: **New** | Add to watch list
 Sale ends in: 05h 47m 04s
 Quantity: 2 available

Was: ~~US \$524.99~~

You save: \$73.50 (14% off)

Price: **US \$451.49**
 From \$41 for 12 months*

Buy It Now

Add to cart

1 watching

Add to watch list

Add to collection

Experienced seller

Free shipping

30-day returns

Shipping: **FAST 'N FREE**
 On or before **Thu. Nov. 17** to 64109

Item location: Westland, Michigan, United States

Ships to: United States [See exclusions](#)

Payments: **PayPal** VISA

Credit Cards processed by PayPal

PayPal CREDIT

* From \$41 for 12 months. Minimum purchase required.

[Apply Now](#) | [See Terms](#)

[See details](#)

Returns: 30 days money back, buyer pays return shipping |

[See details](#)

Guarantee: [See details](#) | [See](#)

[details](#)

Get the item you ordered or get your money back.
 Covers your purchase price and original shipping.

Seller information
 classicparts4u (36541)
 99.7% Positive feedback

Follow this seller

Visit store: classicparts4u
 See other items

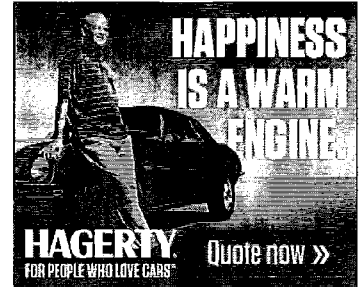

Have one to sell?

Sell now

People who viewed this item also viewed

[Feedback on our suggestions](#)

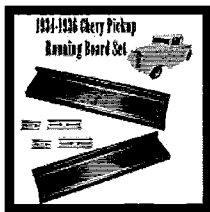

1934 1935 1936 Chevy Pickup Truck 1/2 Ton and
\$369.79
 Free shipping



1937 1938 Pontiac Steel Running Board Set 37,38 -
\$396.88
 Free shipping



1947 48 49 50 51 52 53 54 55 CHEVY PICKUP TRUCK
\$293.25
 Free shipping

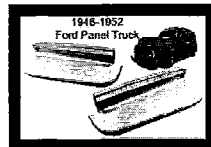

1948 1949 1950 1951 1952 Ford Panel Truck Steel
\$369.79
 Free shipping



1934 Chevrolet Chevy Master Steel Running Board
\$369.79
 Free shipping

Description

Shipping and payments

Report item

Seller assumes all responsibility for this listing.

Last updated on Oct 30, 2016 16:16:57 PDT [View all revisions](#)

eBay item number: 401210658840

Item specifics

Condition: New
 Placement on Vehicle: Left, Right
 Surface Finish: Non Coated Steel
 Country/Region of Manufacture: United States

Brand: ClassicParts4u
 Primary Color: Unfinished
 Manufacturer Part Number: P-3947RB
 Interchange Part Number: 1939, 1940, 1941

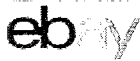

Shop by category

Search...

All Categories



Search

Advanced

Back to search results | Listed in category: eBay Motors > Parts & Accessories > Car & Truck Parts > Exterior > Other



1940-1941 Ford Truck Running Boards - PAIR

Ford Pickup Truck 1/2 TON Steel Running Board Set 40,41 1940-1941 - Made in USA

1 watched in last 24 hours

Item condition: **New**
 Compatibility: See compatible vehicles
 Sale ends in: 05h 21m 03s
 Quantity: 2 available
 Was: ~~US \$455.00~~

You save: \$63.84 (14% off)

Price: **US \$392.15** Buy It Now
 From \$36 for 12 months*

1 watching

Experienced seller | Free shipping | 30-day returns

| Add to watch list

Seller information
 classicparts4u (36541)
 99.7% Positive feedback

Follow this seller

Visit store: classicparts4u
 See other items



LEARN HOW TO EARN \$30 BACK

as a statement credit if you are approved for a new eBay Extras MasterCard® account



Have one to sell? Sell now

Shipping: **FREE** Standard Shipping | [See details](#)

Item location: Westland, Michigan, United States
 Ships to: United States | [See exclusions](#)

Delivery: Estimated on or before **Fri, Nov. 18** to 64109

Payments: **PayPal** VISA

Credit Cards processed by PayPal

PayPal CREDIT

* From \$36 for 12 months. Minimum purchase required.
[Apply Now](#) | [See Terms](#)
[See details](#)

Returns: **30 days money back**, buyer pays return shipping | [See details](#)

Guarantee: [details](#) | [See](#)

Get the item you ordered or get your money back.
 Covers your purchase price and original shipping.

People who viewed this item also viewed

[Feedback on our suggestions](#)



1940-1941 Ford Pickup Truck 1/2 TON Steel
\$392.15
 Free shipping

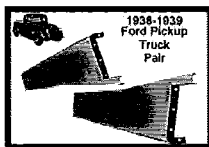

1938-1939 Ford Pickup Truck 1/2 Ton Steel Running
\$374.09
 Free shipping

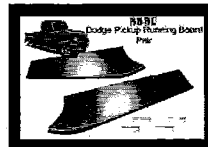

1939-1940 Dodge Pickup Truck
\$451.49
 Free shipping

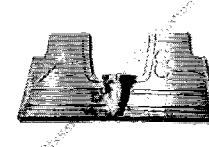

1942-1946 Ford Pickup Truck Complete Front Floor
\$85.49
 Free shipping

Description Shipping and payments

Report item

Seller assumes all responsibility for this listing.

Last updated on Oct 14, 2016 23:55:03 PDT View all revisions

eBay item number: 401207048315



Shop by category

Search...

All Categories



Search

Advanced

Back to search results | Listed in category: eBay Motors > Parts & Accessories > Car & Truck Parts > Exterior > Other

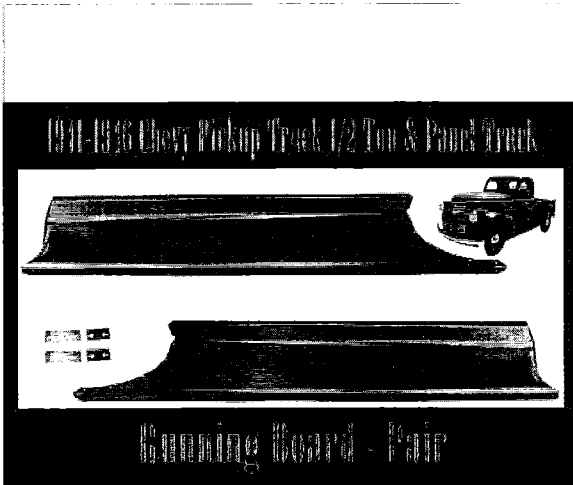

Have one to sell? Sell now

1941 1942 1946 Chevy Pickup Truck & Panel Truck Gmc Steel Running Board Set Pair

1 viewed per hour

Item condition: **New**
 Compatibility: See compatible vehicles
 Time left: 29d 20h 12/11, 9:40PM
 Quantity: 3 available

[Add to watch list](#)

Price: **US \$464.99**
 From \$42 for 12 months

Buy It Now

[Add to cart](#)

[Add to watch list](#)

[Add to collection](#)

Experienced seller Free shipping 30-day returns

Shipping: **FREE Standard Shipping** | [See details](#)

Item location: Westland, Michigan, United States
 Ships to: United States | [See exclusions](#)

Delivery: Estimated on or before **Fri, Nov. 18** to 64109

Payments: **PayPal** VISA

Credit Cards processed by PayPal

PayPal CREDIT

* From \$42 for 12 months. Minimum purchase required.
[Apply Now](#) | [See Terms](#)
[See details](#)

Returns: **30 days money back, buyer pays return shipping** | [See details](#)

Guarantee: [details](#) | [See](#)

Get the item you ordered or get your money back.
 Covers your purchase price and original shipping

Seller information
classicparts4u (36541)
 99.7% Positive feedback

[Follow this seller](#)

Visit store: classicparts4u
[See other items](#)



LEARN HOW TO EARN \$30 BACK

as a statement credit if you are approved for a new eBay Extras MasterCard® account



Description

Shipping and payments

Report item

Seller assumes all responsibility for this listing.

eBay item number: 201715936427

Compatibility

To confirm that this part fits your vehicle, please choose a vehicle from your My Vehicles list OR enter your vehicle's Year, Make and Model.

My Vehicles

Select a vehicle



Year: Make: Model: Trim: Engine:

Manage vehicles

Save to My Vehicles to finds parts faster

[\[show all compatible vehicles\]](#)

This part is compatible with 7 vehicle(s).

Notes	Year	Make	Model	Trim	Engine
	1946	Chevrolet	Truck	All	All
	1946	GMC	Truck	All	All
	1945	Chevrolet	Truck	All	All
	1945	GMC	Truck	All	All
	1944	Chevrolet	Truck	All	All
	1943	Chevrolet	Truck	All	All
	1942	Chevrolet	Truck	All	All

Portions of the information contained in this table have been provided by classicparts4u

Item specifics

Condition: **New**

Brand:



Shop by category

Search...

All Categories



Search

Advanced

Back to search results | Listed in category: eBay Motors > Parts & Accessories > Car & Truck Parts > Exterior > Other



1942 1946 1947 Dodge Pickup Truck Steel Running Boards 42,46,47 NEW PAIR!!

Item **New** | Add to watch list
 condition:
 Compatibility: See compatible vehicles
 Sale ends 05h 39m 20s in.
 Quantity: 2 available / 2 sold
 Was: ~~US \$524.99~~
 You save: \$73.50 (14% off)
 Price: **US \$451.49** Buy It Now
 From \$41 for 12 months*
 Add to cart
 9 watching Add to watch list
 Add to collection
 More than 49% sold Experienced seller Free shipping

Seller information

classicparts4u (36541)
 99.7% Positive feedback

Follow this seller

Visit store: classicparts4u
 See other items



Have one to sell?

Sell now

Shipping: **FAST N FREE**
 On or before **Thu. Nov. 17** to 64109
 Item location: Westland, Michigan, United States
 Ships to: United States [See exclusions](#)

Payments: **PayPal** VISA
 Credit Cards processed by PayPal

PayPal CREDIT
 * From \$41 for 12 months. Minimum purchase required.
[Apply Now](#) | [See Terms](#)
[See details](#)

Returns: **30 days money back**, buyer pays return shipping |
[See details](#)

Guarantee: [details](#) | [See](#)
 Get the item you ordered or get your money back
 Covers your purchase price and original shipping.

Description Shipping and payments

Report item

eBay item number: 142112113338

Seller assumes all responsibility for this listing.

Compatibility

To confirm that this part fits your vehicle, please choose a vehicle from your My Vehicles list OR enter your vehicle's Year, Make and Model

My Vehicles

Select a vehicle

or

Year Make Model Trim Engine

Manage vehicles

Save to My Vehicles to finds parts faster

[\[show all compatible vehicles\]](#)

This part is compatible with 6 vehicle(s).

Notes	Year	Make	Model	Trim	Engine
	1947	Dodge	WC	Base	3.6L 3570CC 218Cu. In. I6 GAS L-HEAD Naturally Aspirated
	1946	Dodge	WC	Base	3.6L 3570CC 218Cu. In. I6 GAS L-HEAD Naturally Aspirated
	1945	Dodge	WC	Base	3.6L 3570CC 218Cu. In. I6 GAS L-HEAD Naturally Aspirated
	1944	Dodge	WC	Base	3.6L 3570CC 218Cu. In. I6 GAS L-HEAD Naturally Aspirated
	1943	Dodge	WC	Base	3.6L 3570CC 218Cu. In. I6 GAS L-HEAD Naturally Aspirated
	1942	Dodge	WC	Base	3.6L 3570CC 218Cu. In. I6 GAS L-HEAD Naturally Aspirated

Portions of the information contained in this table have been provided by classicparts4u

Item specifics

Condition: **New** Brand: **ClassicParts4u**

Hi Michael! Daily Deals Gift Cards Sell Help & Contact

Prep Your Home for Joy

My eBay



Shop by category

Search...

All Categories



Search

Advanced

Back to search results | Listed in category: eBay Motors > Parts & Accessories > Car & Truck Parts > Exterior > Other

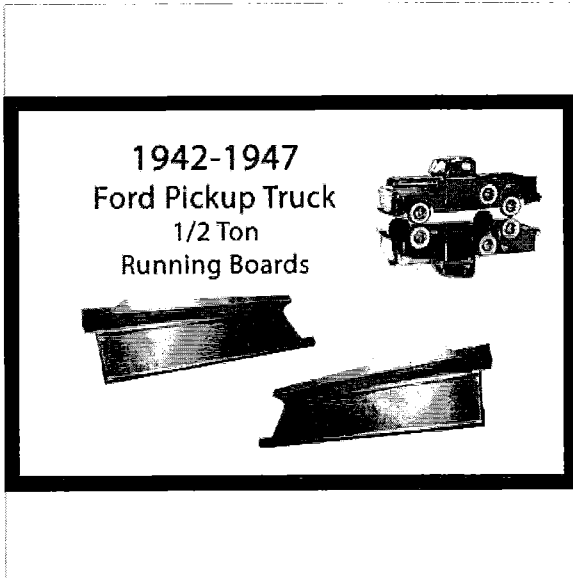

1942 1946 1947 Ford Pickup Truck 1/2 Ton Steel Running Board Set PAIR!

1 watched in last 24 hours

Item condition: **New**
 Compatibility: See compatible vehicles

Sale ends in: 05h 13m 06s

Quantity: 2 available

Was: US-\$461.49

You save: \$64.61 (14% off)

Price: **US \$396.88** Buy It Now
From \$36 for 12 months*

4 watching

Experienced seller Free shipping 30-day returns

Shipping: **FAST N FREE**
 On or before **Thu. Nov. 17** to 64109
Item location: Westland, Michigan, United States
 Ships to: United States [See exclusions](#)

Payments: **PayPal VISA**
Credit Cards processed by PayPal

PayPal CREDIT
* From \$36 for 12 months. Minimum purchase required.
[Apply Now](#) | [See Terms](#)
[See details](#)

Returns: **30 days money back, buyer pays return shipping**
[See details](#)

Guarantee: [See details](#)
Get the item you ordered or get your money back.
 Covers your purchase price and original shipping.

Seller information
 classicparts4u (36541)
 99.7% Positive feedback

[Follow this seller](#)
[Visit store classicparts4u](#)
[See other items](#)

Loading...

Have one to sell? [Sell now](#)

Description Shipping and payments Report item

eBay item number: 401214746602

Seller assumes all responsibility for this listing.
 Last updated on Oct 30, 2016 15:58:47 PDT [View all revisions](#)

Compatibility

To confirm that this part fits your vehicle, please choose a vehicle from your My Vehicles list OR enter your vehicle's Year, Make and Model.

My Vehicles

Select a vehicle or

Manage vehicles

Save to My Vehicles to finds parts faster

[\[show all compatible vehicles\]](#)

This part is compatible with 19 vehicle(s).

Notes	Year	Make	Model	Trim	Engine
	1947	Ford	1/2 Ton Pickup	Base	--
	1947	Ford	1/2 Ton Pickup	Base	3.6L 3622CC 221Cu. In. V8 GAS L-HEAD Naturally Aspirated
	1947	Ford	1/2 Ton Pickup	Base	3.7L 3704CC 226Cu. In. I6 GAS L-HEAD Naturally Aspirated
	1947	Ford	1/2 Ton Pickup	Base	3.9L 3924CC 239Cu. In. V8 GAS L-HEAD Naturally Aspirated
	1946	Ford	1/2 Ton Pickup	Base	--
	1946	Ford	1/2 Ton Pickup	Base	3.6L 3622CC 221Cu. In. V8 GAS L-HEAD Naturally Aspirated
	1946	Ford	1/2 Ton Pickup	Base	3.7L 3704CC 226Cu. In. I6 GAS L-HEAD Naturally Aspirated
	1946	Ford	1/2 Ton Pickup	Base	3.9L 3924CC 239Cu. In. V8 GAS L-HEAD Naturally Aspirated
	1945	Ford	1/2 Ton Pickup	1/2 Ton	--
	1945	Ford	1/2 Ton Pickup	Base	3.6L 3622CC 221Cu. In. V8 GAS L-HEAD Naturally Aspirated



Shop by category

Search...

All Categories



Search

Advanced

Back to search results | Listed in category: eBay Motors > Parts & Accessories > Car & Truck Parts > Exterior > Other

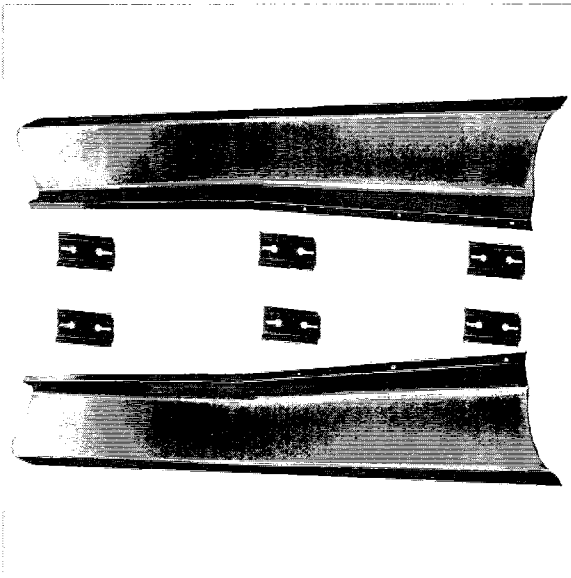

1947 48 49 50 51 52 53 54 55 CHEVROLET CHEVY GMC TRUCK STEEL RUNNING BOARDS PAIR

CHEAPEST ON E-BAY FOR THE PAIR!!!

1 watched in last 24 hours

Item condition: **New** | Add to watch list

Compatibility: See compatible vehicles

Sale ends in: **06h 30m 17s**

Quantity: Last one / 1 sold

Was: **US \$340.99**

You save: **\$47.74 (14% off)**

Price: **US \$293.25** Buy It Now

Add to cart

15 watching | Add to watch list | Add to collection

Seller information
classicparts4u (36540)
 99.7% Positive feedback

Follow this seller

Visit store: classicparts4u
 See other items

FedEx Office offers convenient hours for your holiday shipping. It's how the holidays arrive.

[Find location](#)



Have one to sell? Sell now

More than 49% sold | Experienced seller | Free shipping

Shipping: **FAST 'N FREE**
 On or before **Thu, Nov. 17** to 64109
 Item location: Westland, Michigan, United States
 Ships to: United States | [See exclusions](#)

Payments: **PayPal** | | |

Credit Cards processed by PayPal

PayPal CREDIT
 6 months to pay on \$99+ | [Apply Now](#) | [See Terms](#)
[See details](#)

Returns: **30 days money back, buyer pays return shipping** | [See details](#)

Guarantee: | [See details](#)
 Get the item you ordered or get your money back. Covers your purchase price and original shipping

People who viewed this item also viewed

Feedback on our suggestions

- | | | | | | |
|---|---|---|---|---|---|
| | | | | | |
| 1947 48 49 50 51 52 53 54 55 CHEVY PICKUP TRUCK | 1947-54 Chevrolet Chevy Pickup Truck Taller Stock | 47 48 49 50 - 55 Chevy Truck Headlamp Headlight | 1947 1948 1949 1950 1951 1952 1953 1954 CHEVY | 1958 CHEVY CHEVROLET TRUNK PAN ALL MODELS | 1961 1962 1963 1964 1965 1966-1970 SCOUT 80 & |
| \$293.25 | \$137.59 | \$33.99 | \$92.87 | \$143.40 | \$84.06 |
| Free shipping | Free shipping | Free shipping | Free shipping | Free shipping | Free shipping |

Description | Shipping and payments | Report item

Seller assumes all responsibility for this listing.





eBay item number 201704164916

Compatibility
 To confirm that this part fits your vehicle, please choose a vehicle from your My Vehicles list OR enter your vehicle's Year, Make and Model.

Website listing

https://c2c2fabrication.com/ running board - Page 2

Select Make Select Model Select Year SUBMIT

<p>\$ 314.59</p> <p>Quantity 1</p> <p>ADD TO CART</p>  <p>SKU 435-4047-L</p> <p>1947 - 1955 GMC Fullsize Truck Short Bed (55 1st Design) Short Bed LH Running Board Assembly (Paintable)</p> <p>\$ 271.69</p> <p>Quantity 1</p> <p>ADD TO CART</p>	<p>\$ 271.69</p> <p>Quantity 1</p> <p>ADD TO CART</p>  <p>SKU 435-4047-CR</p> <p>1947 - 1955 GMC Fullsize Truck Short Bed (55 1st Design) Short Bed RH Running Board Assembly (Chrome)</p> <p>\$ 314.59</p> <p>Quantity 1</p> <p>ADD TO CART</p>	<p>\$ 314.59</p> <p>Quantity 1</p> <p>ADD TO CART</p>  <p>SKU 435-4047-R</p> <p>1947 - 1955 GMC Fullsize Truck Short Bed (55 1st Design) Short Bed RH Running Board Assembly (Paintable)</p> <p>\$ 271.69</p> <p>Quantity 1</p> <p>ADD TO CART</p>	<p>\$ 271.69</p> <p>Quantity 1</p> <p>ADD TO CART</p>  <p>SKU 557-225</p> <p>1953-1954 Ford Pickup Smooth Running Boards Set</p> <p>\$ 374.99</p> <p>Quantity 1</p> <p>ADD TO CART</p>	<p>\$ 314.59</p> <p>Quantity 1</p> <p>ADD TO CART</p>  <p>SKU 567-225</p> <p>1948-1953 Ford F-1 Pickup Smooth Running Boards Set</p> <p>\$ 429.99</p> <p>Quantity 1</p> <p>ADD TO CART</p>
---	---	---	---	---

Previous Page 2 of 2 Next



(http://c2cfabrication.com) Search



Select Make

Select Model

Select Year

SUBMIT

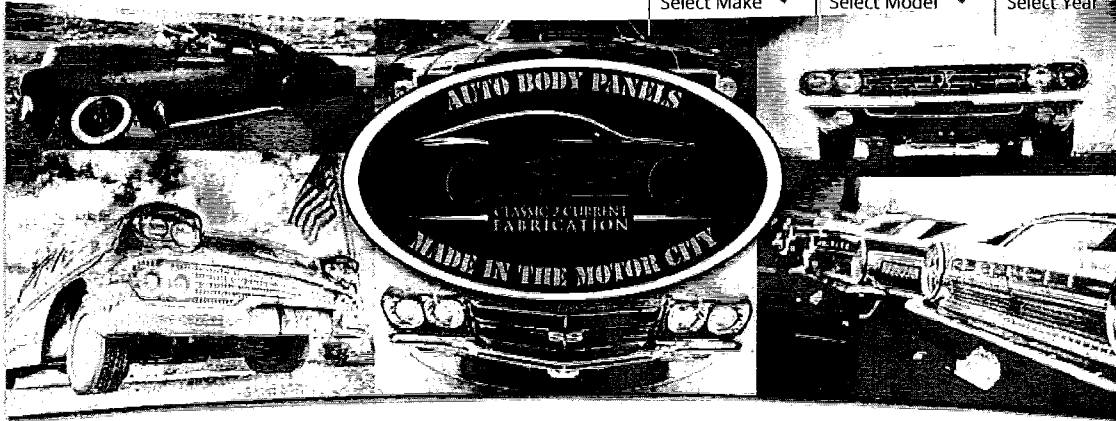

(/)



Home (/) / Products (/collections/all) / 1948-1952 Ford F-1 Pickup Smooth Running Boards Set

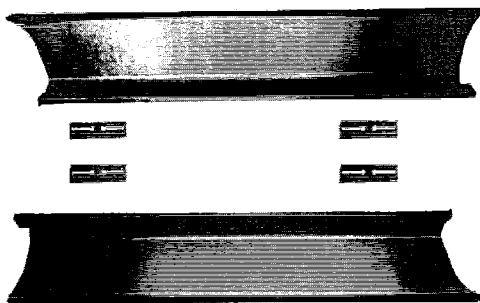

1948-1952 Ford F-1 Pickup Smooth Running Boards Set

SKU 567-225

\$ 429.99

Tweet G+1

Like 0

Quantity 1

ADD TO CART

[View fullsize image](#)

[Email us about this product \(mailto:sales@c2cfabrication.com?Subject=1948-1952 Ford F-1 Pickup Smooth Running Boards Set\)](mailto:sales@c2cfabrication.com?Subject=1948-1952 Ford F-1 Pickup Smooth Running Boards Set)

Ford F-1 Pickup Smooth Running Boards, Set

1948-1952 Ford F-1 Pickup Smooth Running Boards, Set 16ga with Adapters

Running Board

Years: 1948,1950,1951,1952

Ford Pickup

Make/Model Years Shipping Material

Ford Pickup



Shop by category

Search...

All Categories



Search

Advanced

Back to search results | Listed in category: eBay Motors > Parts & Accessories > Car & Truck Parts > Exterior > Other

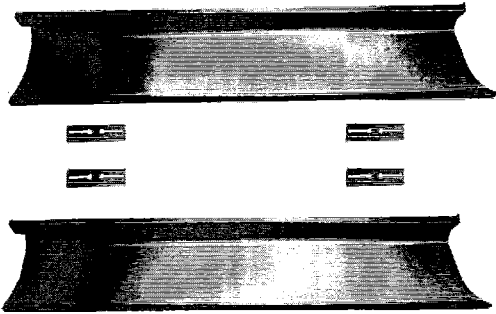

1948 1949 1950 1951 1952 Ford F-1 Pickup Truck Steel Running Boards New pair!! CHEAPEST ON E-BAY!!!

👁️ 2 watched in fast 24 hours

Item condition: **New**
Compatibility: See compatible vehicles

[Add to watch list](#)

Sale ends in: 06h 23m 11s

Quantity: 2 available

Was: ~~US \$429.99~~

You save: \$60.20 (14% off)

Price: **US \$369.79** Buy It Now
From \$34 for 12 months*

[Add to cart](#)

4 watching [Add to watch list](#)
[Add to collection](#)

Experienced seller Free shipping 30-day returns

Shipping: **FAST 'N FREE**
On or before **Thu. Nov. 17** to 64109
Item location: Westland, Michigan, United States
Ships to: United States [See exclusions](#)

Payments: **PayPal** VISA
Credit Cards processed by PayPal

PayPal CREDIT
* From \$34 for 12 months. Minimum purchase required.
[Apply Now](#) | [See Terms](#)
[See details](#)

Returns: 30 days money back, buyer pays return shipping | [See details](#)

Guarantee: [details](#) | [See](#)
Get the item you ordered or get your money back.
Covers your purchase price and original shipping.

Seller information
classicparts4u (36540)
 99.7% Positive feedback

[Follow this seller](#)

Visit store: classicparts4u
[See other items](#)

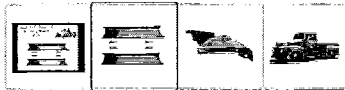

Have one to sell? [Sell now](#)

People who viewed this item also viewed

[Feedback on our suggestions](#)



2002-2008 Dodge Ram Quad Cab & Club Cab 4Door
\$171.99
Free shipping



1949 50 51 FORD DRIVER SIDE FULL LENGH FRONT
\$108.78
Free shipping



1947-54 Chevrolet Chevy Pickup Truck Taller Stock
\$137.59
Free shipping

Description Shipping and payments

[Report item](#)

Seller assumes all responsibility for this listing.

eBay item number: 142173222089

Compatibility

To confirm that this part fits your vehicle, please choose a vehicle from your My Vehicles list OR enter your vehicle's Year, Make and Model.



Shop by category

Search...

All Categories



Search

Advanced

Back to search results | Listed in category: eBay Motors > Parts & Accessories > Car & Truck Parts > Exterior > Other

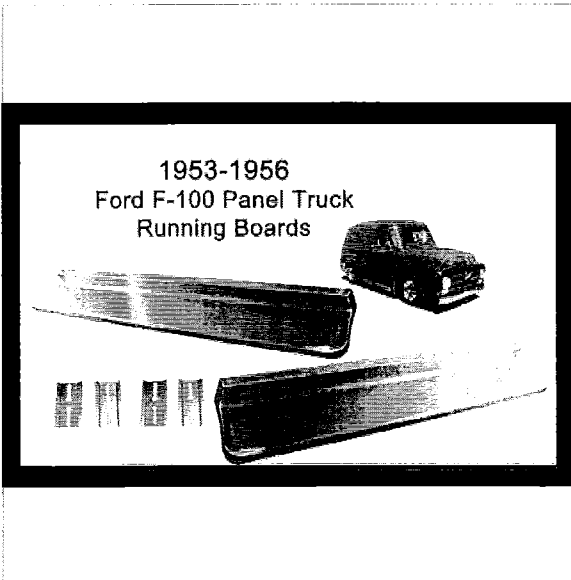

1953-1956 Ford F-100 Panel Truck Running Boards

1953 1954 1955 1956 Ford F-100 Panel Truck Steel Running Board Set 53,54,55,56 CHEAPEST ON E-BAY!!!

Item condition: New

| Add to watch list

Sale ends in: 05h 23m 12s

Quantity: 1 4 available

Was: US \$389.99

You save: \$54.60 (14% off)

Price: US \$335.39 From \$31 for 12 months*

Buy It Now

Add to cart

2 watching

Add to watch list

Add to collection

Experienced seller

Free shipping

30-day returns

Seller information

classicparts4u (36541) 99.7% Positive feedback

Follow this seller

Visit store: classicparts4u

See other items



LEARN HOW TO EARN \$30 BACK

as a statement credit if you are approved for a new eBay Extra MasterCard® account.

Learn More

Shipping: FAST 'N FREE

On or before Thu. Nov. 17 to 64109

Item location: Westland, Michigan, United States

Ships to: United States. See exclusions

Payments: PayPal VISA MasterCard Discover

Credit Cards processed by PayPal

PayPal CREDIT

* From \$31 for 12 months. Minimum purchase required

Apply Now | See Terms

See details

Returns: 30 days money back, buyer pays return shipping |

See details

Guarantee:

| See

details

Get the item you ordered or get your money back. Covers your purchase price and original shipping.

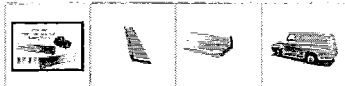

Have one to sell?

Sell now

People who viewed this item also viewed

Feedback on our suggestions

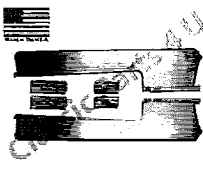

Ford F-100 Pickup Truck Steel Running Board SET 53 \$318.19 Free shipping

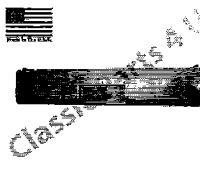

1951 - 1956 FORD TRUCK F100 F-100 Pickup STEEL \$146.19 Free shipping

Description

Shipping and payments

Report item

Seller assumes all responsibility for this listing.

eBay Item number: 142159472759

Item specifics

Condition: New

Brand:

ClassicParts4u

Country of Manufacture: United States

Primary Color:

Unfinished

Part Brand: ClassicParts4U

Manufacturer Part Number:

F-5356RBP

Placement on Vehicle: Left, Right

Surface Finish:

Non Coated Steel

Home page



Search



Extended Cab Universal Rocker Panel

\$ 29.99

Quantity 1



SKU 991-55CL

1999-2007 Chevy Silverado Pickup Cab Corner -ldr Crew Cab LH

\$ 32.98

Quantity 1



Cab Pickup Cab Corner LH

\$ 19.20

Quantity 1

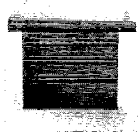

SKU 320-013-1

1956-1971 Dodge Pickup (C-Series) Outer Rocker Panel w/ Step Plate LH

\$ 29.99

Quantity 1



Complete Front Floor Pan

\$ 79.99

Quantity 1



SKU 575-020-1

1980-98 Ford F-150 Outer Rocker Panel, LH

\$ 29.99

Quantity 1



Cab Corner 2dr Standard Cab LH

\$ 45.11

Quantity 1



SKU 550-012-1

1999-2011 Ford Pickup Truck Cab/Super Duty Inner Rocker Panel LH

\$ 43.00

Quantity 1



Floor Pan, RH

\$ 64.99

Quantity 1



SKU 568-225

1953-1956 Ford F-100 Pickup Smooth Steel Running Board Set

\$ 399.99

Quantity 1

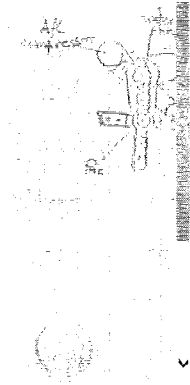
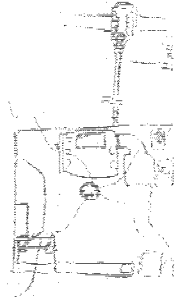



(http://c2cfabrication.com) Search



Select Make

Select Model

Select Year

SUBMIT

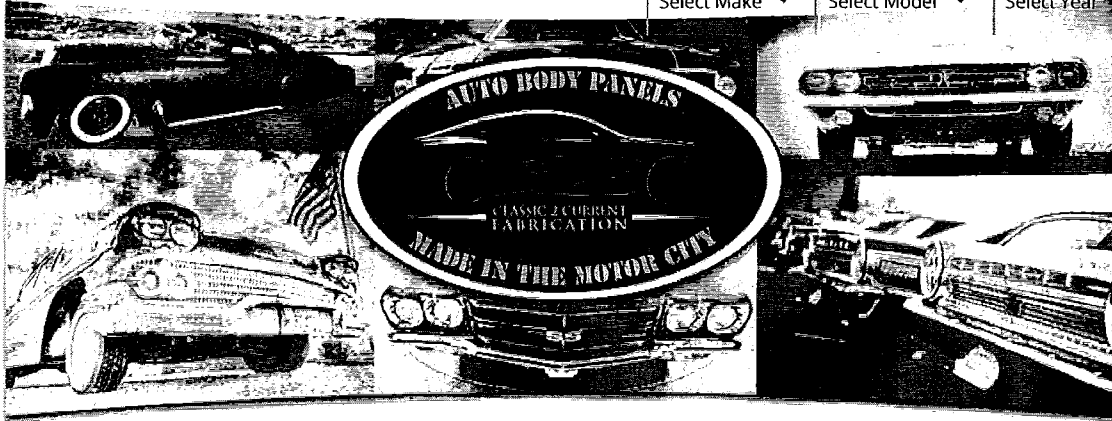

(/)



Home (/) / Collections (/collections) / Items That Ship For Free (/collections/free-shipping) / 1953-1956 Ford F-100 Pickup Smooth Steel Running Board Set

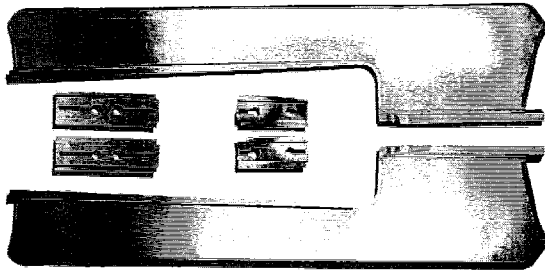

1953-1956 Ford F-100 Pickup Smooth Steel Running Board Set

SKU 568-225

\$ 399.99

[View fullsize image](#)

[Email us about this product \(mailto:sales@c2cfabrication.com?Subject=1953-1956 Ford F-100 Pickup Smooth Steel Running Board Set\)](mailto:sales@c2cfabrication.com?Subject=1953-1956 Ford F-100 Pickup Smooth Steel Running Board Set)

Tweet

G+1

Like 1

Quantity

1

ADD TO CART

Ford F-100 Pickup Smooth Steel Running Board Set

1953-1956 Ford F-100 Pickup Smooth Steel Running Board Set

For Years: 1953, 1954, 1955, 1956

Ford F-100 Pickup Running Board Set

- Heavy 16 Gauge Steel
- Complete set of left and right Running Boards with adapters to fit your original braces
- Non-ribbed
- Made in USA

FREE SHIPPING

Make/Model Years Shipping Material

Ford F-100 Pickup

Classic 2 Current Fabrication

Departments

Browsing History

Linda's Amazon.com

Today's Deals

Hello, Linda
Your Account

Prime

Lists

0

Cart

Automotive

Your Garage

Deals & Rebates

Best Sellers

Parts

Accessories

Tools & Equipment

Car Care

Motorcycle & Powersports

Truck

Find parts for your: 1969 Chevrolet Chevelle Go

Your Garage (2)

COUNTDOWN TO
BLACK FRIDAY
DEALS WEEK

Get notified when deals go live



Back to results



1953-56 Ford F-100 Pickup Smooth Steel Running Board Set

by Classic 2 Current Fabrication
Be the first to review this item

Price: \$374.99 + \$13.58 shipping

Note: Not eligible for Amazon Prime.

In Stock.

Get it as soon as Nov. 17 - 22 when you upgrade to Standard at checkout.

Ships from and sold by Classic 2 Current Fabrication.

- 1953-56 Ford F-100 Pickup Smooth Steel Running Board Set
- Heavy gauge steel will not give way like fiberglass boards
- Complete set of left and right hand running boards. Non ribbed smooth boards allow you to finish as desired.
- High quality set of 16 Gauge Steel running boards with adapters to fit to your original braces
- Made in the USA
- › See more product details

New (1) from \$374.99 + \$13.58 shipping

Report incorrect product information.

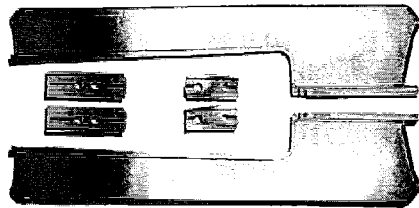

Roll over image to zoom in

The Automotive
Holiday Gift Guide
For the car lover in your life



Shop now

Share

Qty: 1

\$374.99 + \$13.58 shipping
In Stock. Sold by **Classic 2 Current Fabrication**

Add to Cart

Turn on 1-Click ordering for this browser

Ship to:

Carotek Inc- Matthews - 28105

Add to List

Universal Thermoplastic
Teardrop Shift Knob



Mishimoto MMSK-TDP-WH White
Teardrop Shift Knob
~~\$430.00~~ \$56.25

Ad feedback

Sponsored Products Related To This Item (What's this?)

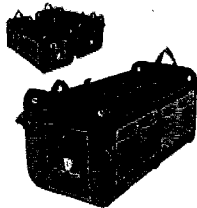

TrunkCratePro TC-PRO01 Multipurpose 11 Pocket Premium Cargo Trunk Organizer for...

183
\$38.87



Versatile Trunk Organizer by TRUNKZY - Premium Storage Container for Car, SUV, Truck or...

59
\$27.97

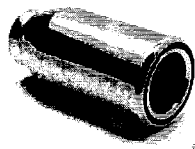

Exhaust Tip Stainless Steel 3 Rd Double Wall 2 Inlet Wesdon Exhaust Tip

4
\$29.99



Exhaust X Pipe Diameter Dual 3.00" Diameter Outlets WXPk:

\$139.99

Ad feedback

Customers Also Shopped For

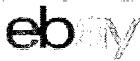

Shop by category

Search...

All Categories



Search

Advanced

Back to search results | Listed in category: eBay Motors > Parts & Accessories > Car & Truck Parts > Exterior > Other

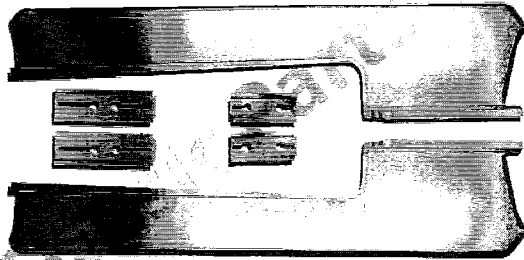

1953 1954 1955 1956 Ford Pickup Truck F-100 Steel Running Board SET 53 54 55 56

CHEAPEST ON E-BAY!!!

1 watched in last 24 hours

Item condition: **New**

Compatibility: See compatible vehicles

Sale ends in: **05h 02m 13s**

Quantity: Last one / 1 sold

Was: ~~US \$369.99~~

You save: \$51.80 (14% off)

Price: **US \$318.19** Buy It Now
From \$29 for 12 months*

3 watching

More than 49% sold | Last item available | Experienced seller

Shipping: **FAST 'N FREE**
On or before **Thu. Nov. 17** to 64109
Item location: Westland, Michigan, United States
Ships to: United States | See exclusions

Payments: **PayPal** | VISA | MasterCard | American Express
Credit Cards processed by PayPal

PayPal CREDIT
* From \$29 for 12 months. Minimum purchase required
[Apply Now](#) | [See Terms](#)
[See details](#)

Returns: 30 days money back, buyer pays return shipping | [See details](#)

Guarantee: [See details](#)

Get the item you ordered or get your money back.
Covers your purchase price and original shipping.

| Add to watch list

Seller information
classicparts4u (36542)
99.7% Positive feedback

Follow this seller

Visit store: classicparts4u
See other items



LEARN HOW TO EARN \$30 BACK

as a statement credit if you are approved for a new eBay Extra MasterCard® account.

[Learn More](#)

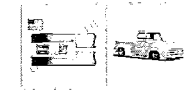

Have one to sell? [Sell now](#)

People who viewed this item also viewed

[Feedback on our suggestions](#)



1953 1954 1955 1956 Ford
f-100 Pickup Truck Firewall
\$322.49
Free shipping

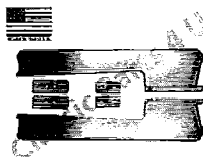

Ford F-100 Pickup Truck
Steel Running Board SET 53
\$318.19
Free shipping



1953-1956 F100 Firewall
\$322.49
Free shipping



1953-1956
Ford Truck
Lower Door Skins-PAIR
\$94.59
Free shipping

Description

Shipping and payments

Report item

Seller assumes all responsibility for this listing

eBay item number: 201711531150

Compatibility



amazon Prime

Classic 2 Current Fabrication

HOLIDAY **TOY** LIST Sponsored by Skylanders Imaginators

Departments [Browse History](#) [Rebecca's Amazon.com](#) [Today's Deals](#) [Gift Cards & Registry](#) [Sell](#) [Help](#)

Automotive [Your Garage](#) [Deals & Rebates](#) [Best Sellers](#) [Parts](#) [Accessories](#) [Tools & Equipment](#) [Car Care](#) [Motorcycles & Powersports](#) [Trucks](#) [Jeep](#) [RV](#) [Tires & Wheels](#) [Vehicles](#)

Find parts for your:

COUNTDOWN TO BLACK FRIDAY Get notified when deals go live

Automotive [Replacement Parts](#) [Body & Trim](#) [Body](#) [Floor Parts](#)

1953-56 Ford F-100 Pickup Smooth Steel Running Board Set
by Classic 2 Current Fabrication
Be the first to review this item

Price: **\$374.99** + \$13.58 shipping

Note: Not eligible for Amazon Prime.

In Stock.
Get it as soon as Nov. 22 - 28 when you upgrade to Standard at checkout.
Ships from and sold by Classic 2 Current Fabrication.

- 1953-56 Ford F-100 Pickup Smooth Steel Running Board Set
- Heavy gauge steel will not give way like fiberglass boards
- Complete set of left and right hand running boards. Non ribbed smooth boards allow you to finish as desired.
- High quality set of 19 Gauge Steel running boards with adapters to fit to your original braces
- Made in the USA

See more product details

New (1) from \$374.99 + \$13.58 shipping
 Report incorrect product information.

Share

Qty:

\$374.99 + \$13.58 shipping
In Stock. Sold by **Classic 2 Current Fabrication**

Turn on 1-Click ordering for this browser

Ship to:
Rebecca Harasnowski - Charlotte - 28217

Your Garage (1)

ClassAction.org

This complaint is part of ClassAction.org's searchable class action lawsuit database and can be found in this post: [Smoothie Fabrication Hit with Copyright Infringement Class Action](#)
